

# Glasopeningen

Zoveel wensen, zoveel smaken. Daarom bestaat er binnen het Krepel assortiment een grote keuze in glasopeningen. Klassiek of modern, geheel naar de verlangde sfeer. In bijgaande tabel krijgt u een indicatie van de verschillende types en beschikbaarheid.



roedeverdeling





Type 01 dicht

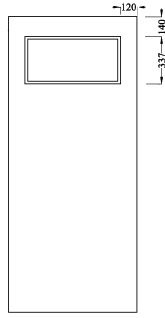

02 kleine glasopening



03 glasopening

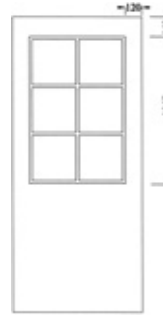

03 met 6-vaks roedeset

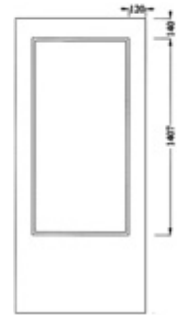

04 grote glasopening

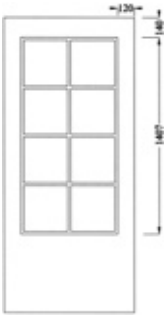

04 met 8-vaks roedeset



08 smalle glasopening

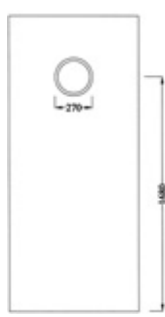

10 ronde glasopening

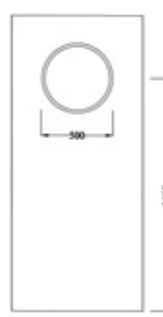

23 ronde glasopening

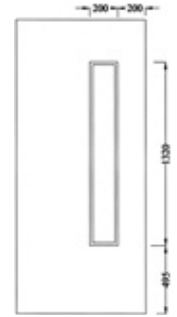

41 smalle glasopening



53 smalle glasopening



58 dubbele smalle glasopening excentrisch



69 met 10-vaks roedeset

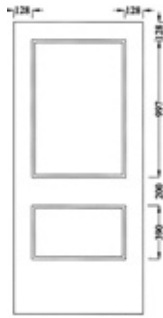

64 dubbele glasopening



69 grote glasopening

Uiteraard afwijkende glasopening mogelijk op aanvraag.

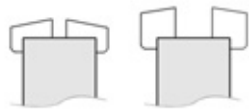

type 100

type 200



type 300

type 400



type A

type B



type 500

standaard



type C

type D

glaslatten voor rechthoekige glasopening

glaslatten voor ronde of "halve maan" glasopening



## Draairichtingen van deuren

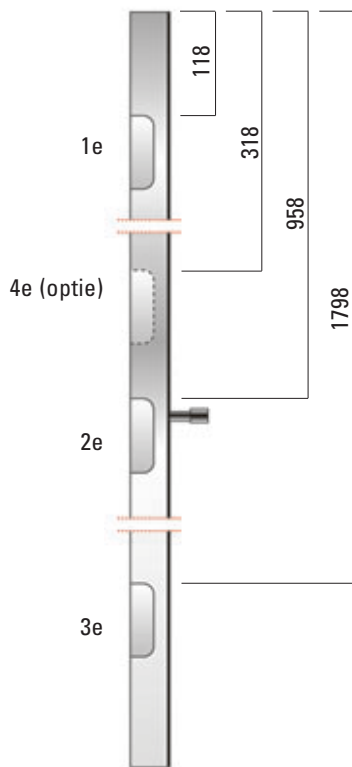
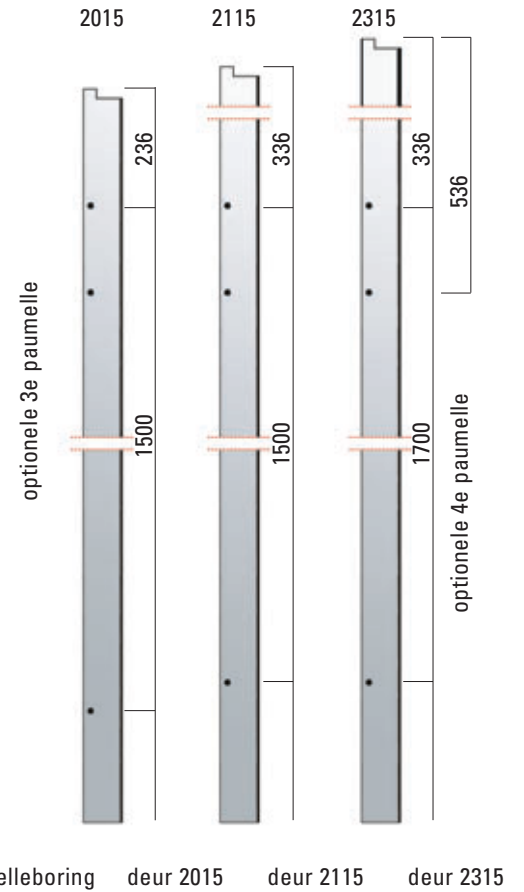
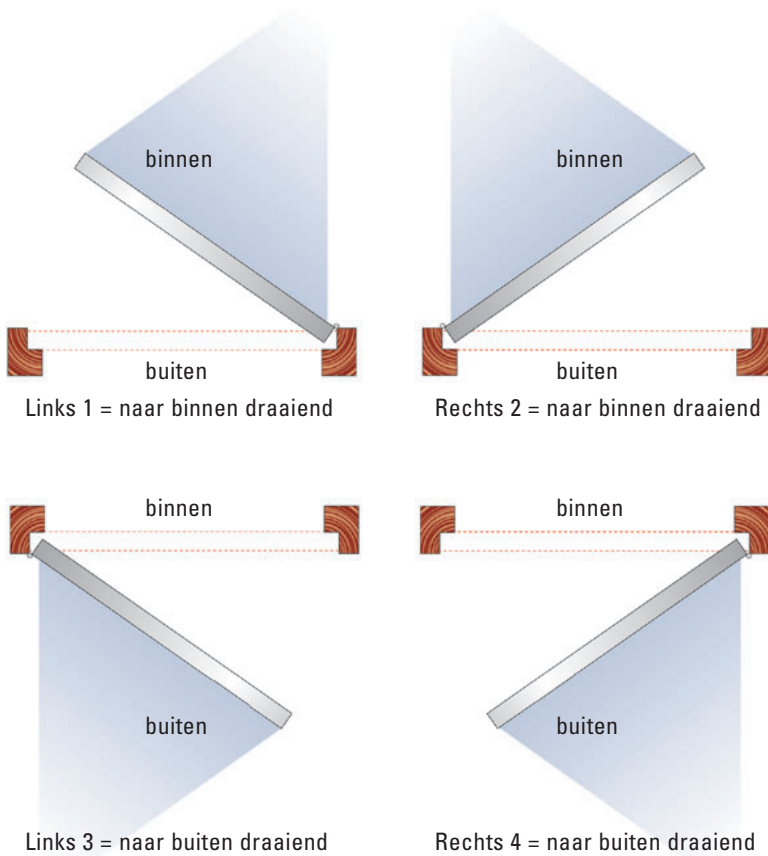

## Inkrozingen t.b.v. scharnier

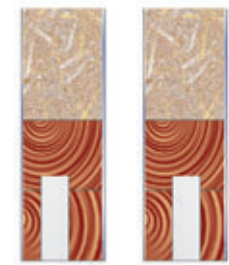
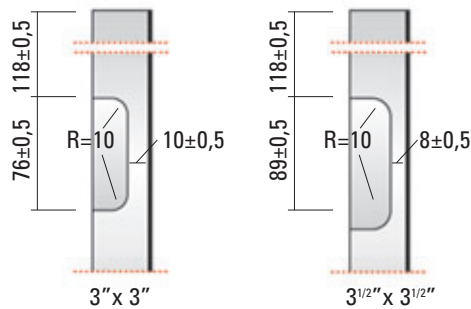

## Doorsnede inkrozingen scharnier

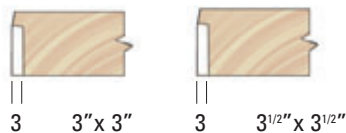

Arm schaven aan de sluitzijde 2°

Rijke maat: sponningmaat +/- 4 à 5 mm

Deurhoogte: 2015 - 2115 - 2315

Bovenzijde draainaad: 2 mm